



Axial Lead Diode

Avalanche Diode

SKa 1

Features

- Avalanche type reverse characteristic
- Transient voltage proof within specified limits
- Taped for automatic insertion
- Available with formed leads on request
- Plastic material used carries Underwriter Laboratories flammability classification 94V-0

Typical Applications*

- DC supply for magnetes or solenoids (brakes, valves etc.)
- Series connections for high voltage applications (dust precipitators)



$V_{(BR)min}$	$I_{FRMS} = 3\text{ A}$ (maximum value for continuous operation)	C_{max}	R_{min}
V	$I_{FAV} = 1\text{ A}$ (sin. 180; $T_a = 60\text{ °C}$)	μF	Ω
1300	SKa 1/13	400	6
1700	SKa 1/17	200	10

Symbol	Conditions	Values	Units
I_{FAV}	$T_r = 85\text{ °C}$; L = 10 mm; sin. 180	1,45	A
I_{FAV}	$T_a = 45\text{ °C}$; PCB 50 x 50 mm	1,15	A
I_{FSM}	$T_{vj} = 25\text{ °C}$; 10 ms	60	A
	$T_{vj} = 150\text{ °C}$; 10 ms	50	A
i^2t	$T_{vj} = 25\text{ °C}$; 8,3 ... 10 ms	18	A ² s
	$T_{vj} = 150\text{ °C}$; 8,3 ... 10 ms	12,5	A ² s
V_F	$T_{vj} = 25\text{ °C}$; $I_F = 10\text{ A}$	max. 1,5	V
$V_{(TO)}$	$T_{vj} = 150\text{ °C}$	max. 0,85	V
r_T	$T_{vj} = 150\text{ °C}$	max. 75	m Ω
I_{RD}	$T_{vj} = 150\text{ °C}$; $V_{RD} = V_{(BR)min}$	max. 400	μA
P_{RSM}	$T_{vj} = 150\text{ °C}$; $t_p = 10\text{ }\mu\text{s}$	1	kW
$R_{th(j-r)}$	L = 10 mm	40	K/W
$R_{th(j-a)}$	PCB 50 x 50 mm	85	K/W
T_{vj}		- 40 ... + 150	$^{\circ}\text{C}$
T_{stg}		- 40 ... + 150	$^{\circ}\text{C}$
T_{sold}	max. 10 s; L > 9 mm	250	$^{\circ}\text{C}$
V_{isol}		-	V~
a		5 * 9,81	m/s ²
m	approx.	0,5	g
Case	3500 diodes per reel	E 33	

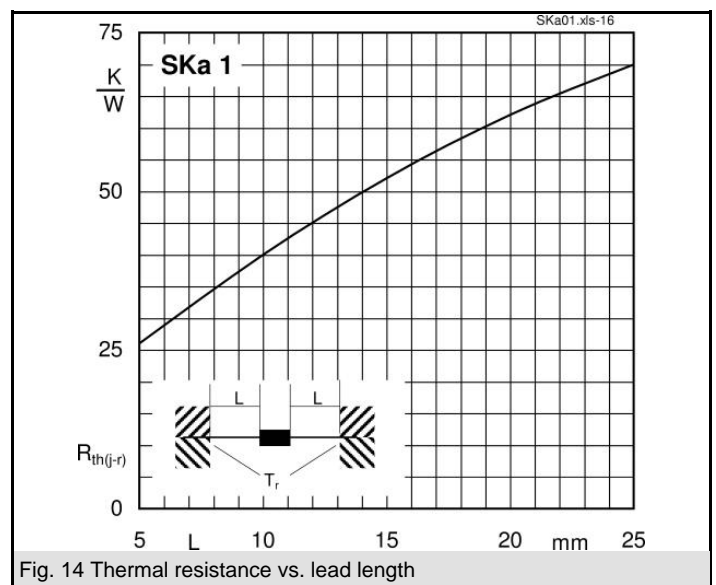
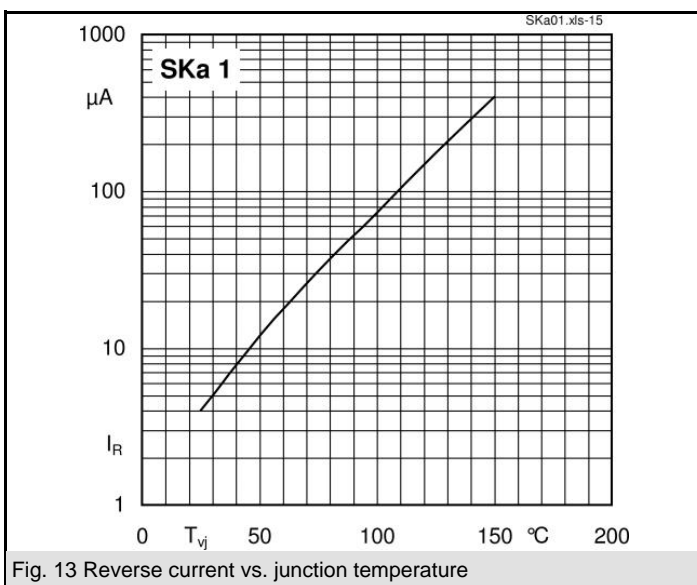
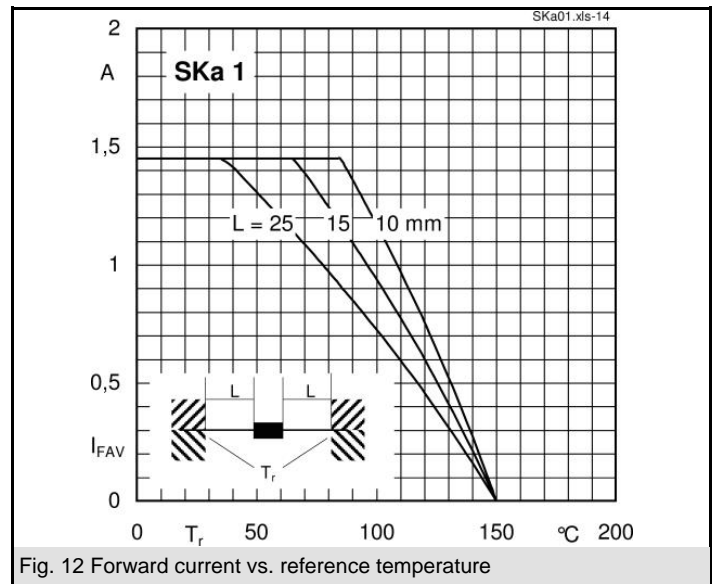
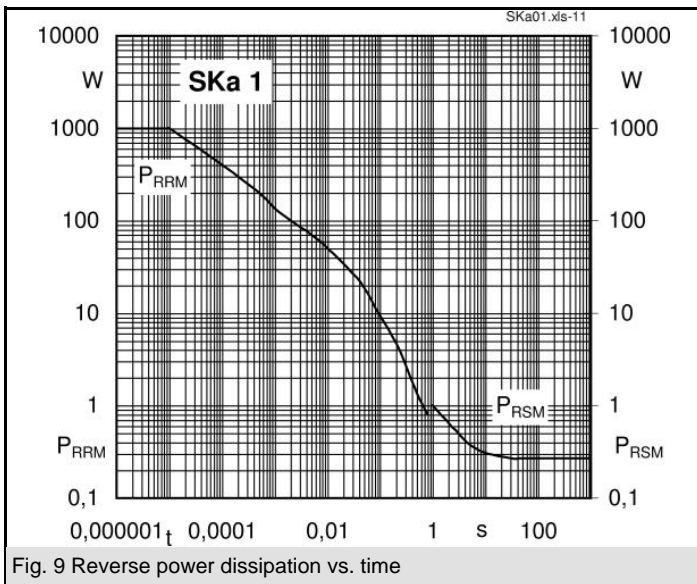
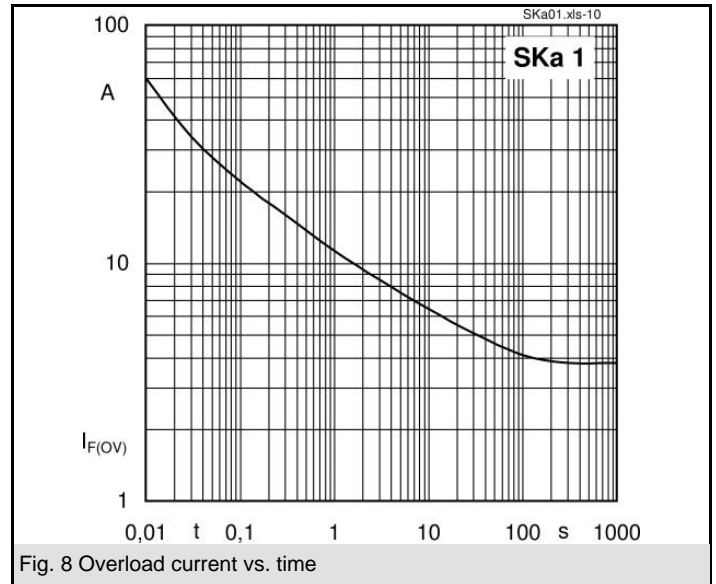
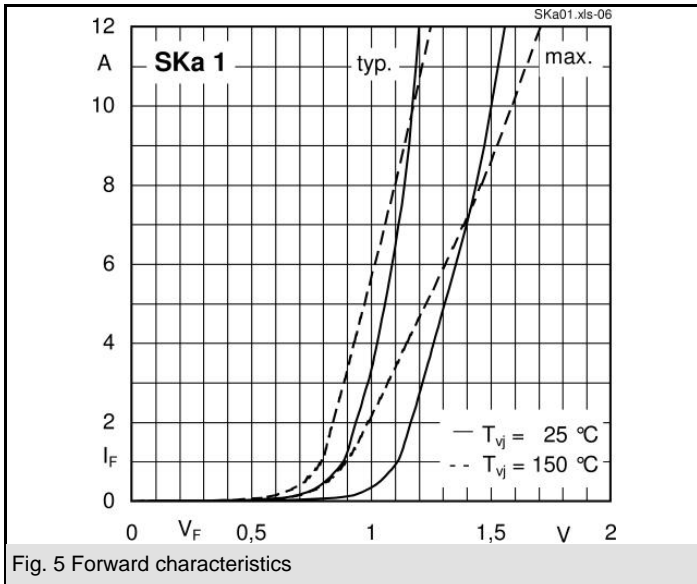

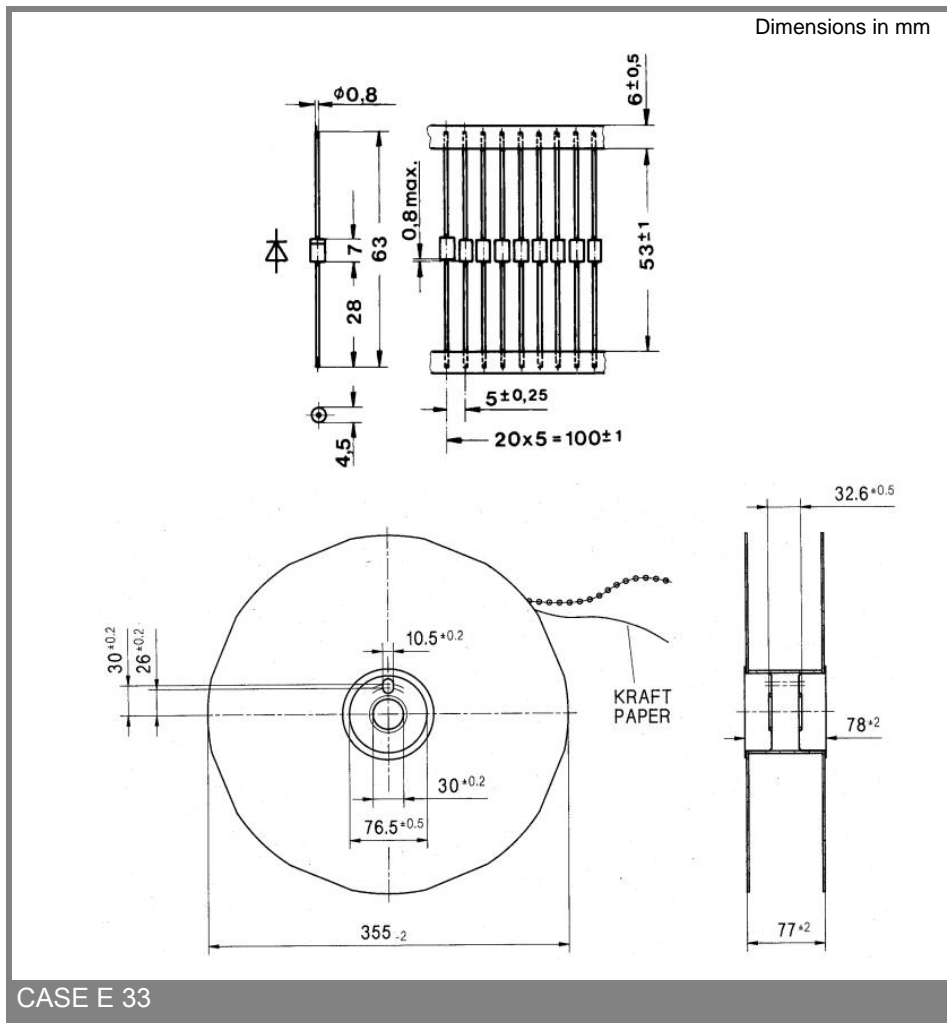

CASE E 33

* The specifications of our components may not be considered as an assurance of component characteristics. Components have to be tested for the respective application. Adjustments may be necessary. The use of SEMIKRON products in life support appliances and systems is subject to prior specification and written approval by SEMIKRON. We therefore strongly recommend prior consultation of our personal.